

## PREISLISTE



### LED Aufbauleuchte "DECO"

DALI / Touch dimmbar / 400mm

ART. NR.	WATT	BEZEICHNUNG	Ra/CRI	KELVIN	LICHTSTROM	IP	PREIS CHF exkl. / inkl. MWSt
<b>SPA-099AL-40D schwarz/weiss</b>	40W	<b>LED Aufbauleuchte «DECO» direkt/indirekt 70/30%, 120° DALI / Touch dim, CRI&gt;80 UGR: &lt;19, Schutzklasse I Aluminium, Microprismatic diffuser, 50/60Hz, 95-265V IP40, Ø400x86mm, 3.8kg</b>	80	3000K/4000K einstellbar	4200lm 4300lm	IP40	299.00 / 322.00
30207		<b>Seilpendel</b> schwarz / weiss passend zu DECO Deckenleuchte		<b>Länge max.: 80cm</b>			49.00 / 52.80
30208		<b>Rohrpendel</b> schwarz / weiss passend zu DECO Deckenleuchte		<b>Länge max.: 50cm</b>			49.00 / 52.80

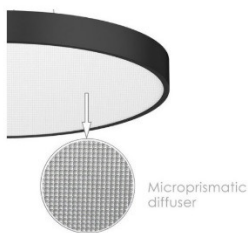

\* = ab Lager lieferbar





## LED Aufbauleuchte "DECO"

DALI / Touch dimmbar / 600mm/800mm/1000mm

ART. NR.	WATT	BEZEICHNUNG	Ra/CRI	KELVIN	LICHTSTROM	IP	PREIS exkl. / inkl. MWSt
<b>SPA-099AL-60D schwarz/weiss</b>	60W	<b>LED Aufbauleuchte «DECO» direkt/indirekt 70/30%, 120°</b> DALI / Touch dim, CRI>80 <b>UGR: &lt;19</b> , Schutzklasse I Aluminium, Microprismatic diffuser, 50/60Hz, 95-265V IP40, Ø600x86mm, 5.8kg	80	3000K/4000K einstellbar 3000K/4000K/ 5700K	6200lm 6300lm	IP40	a/A
<b>SPA-099AL-80D schwarz/weiss</b>	80W	<b>LED Aufbauleuchte «DECO» direkt/indirekt 70/30%, 120°</b> DALI / Touch dim, CRI>80 <b>UGR: &lt;19</b> , Schutzklasse I Aluminium, Microprismatic diffuser, 50/60Hz, 95-265V IP40, Ø800x86mm, 7.8kg	80	3000K/4000K einstellbar 3000K/4000K/ 5700K	8200lm 8300lm	IP40	a/A
<b>SPA-099AL-100D schwarz/weiss</b>	100W	<b>LED Aufbauleuchte «DECO» direkt/indirekt 70/30%, 120°</b> DALI / Touch dim, CRI>80 <b>UGR: &lt;19</b> , Schutzklasse I Aluminium, Microprismatic diffuser, 50/60Hz, 95-265V IP40, Ø1000x86mm, 9.8kg	80	3000K/4000K einstellbar 3000K/4000K/ 5700K	10200lm 10300lm	IP40	a/A

\* = nicht lagernd, 5-6 Wochen Lieferfrist

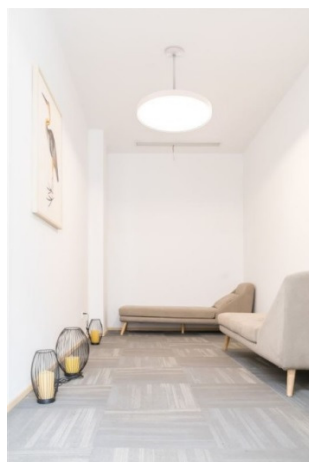

Preise exkl. MWST. Grössere Mengen auf Anfrage. Preisänderungen vorbehalten. Januar 2021



Spatalux GmbH  
 Spechtweg 6  
 CH-8032 Zürich

T +41 (0)44 586 98 90  
 F +41 (0)43 888 42 75  
 info@spatalux.ch  
 www.spatalux.ch



## PREISLISTE



### LED-Aufbaudownlight schwenkbar

Phasen An-&Abschnitt dimmbar

ART. NR.	WATT	BEZEICHNUNG	Ra/CRI	KELVIN	LICHTSTROM	IP	PREIS CHF exkl. / inkl. MWST
SPA-13021-ws	15 Watt	LED-Aufbaudownlight Ø85x186mm, weiss, 36° Aluminium - Ph. dimmbar	80	3000K	1350lm	IP20	91.92 / 99.00
SPA-13021-sz	15 Watt	LED-Aufbaudownlight Ø85x186mm, schwarz, 36° Aluminium - Ph. dimmbar	80	3000K	1350lm	IP20	91.92 / 99.00



### LED-Anbauleuchte 10W+1.6W direkt/indirekt

Phasen An-&Abschnitt dimmbar

ART. NR.	WATT	BEZEICHNUNG	Ra/CRI	KELVIN	LICHTSTROM	IP	PREIS CHF exkl. / inkl. MWST
SPA-13155-ws	10 Watt	LED-Anbaudownlight Ø120x55mm, Weiss, 52° Aluminium - Ph. Dimmbar direct/indirekt	90	3000K	1180lm	IP20	143.91 / 155.00
SPA-13155-sz	10 Watt	LED-Anbaudownlight Ø120x55mm, Weiss, 52° Aluminium - Ph. Dimmbar direct/indirekt	90	3000K	1180lm	IP20	143.91 / 155.00

Grössere Mengen auf Anfrage. Preisänderungen vorbehalten. April 2021



Spatalux GmbH  
 Spechtweg 6  
 CH-8032 Zürich

T +41 (0)44 586 98 90  
 F +41 (0)43 888 42 75  
 info@spatalux.ch  
 www.spatalux.ch



## PREISLISTE



### LED Aufbauleuchten Round 280x45mm

on/off / dimmbar / Bewegungsmelder / NOTLICHT

ART. NR.	WATT	BEZEICHNUNG	Ra/CRI	KELVIN	LICHTSTROM	IP	PREIS CHF exkl. / inkl. MWSt
SPA-AR18	18 Watt	LED AufbauleuchteN Round, Ø280mm H48mm, weiss, <b>on/off</b>	85	3000K/4000K 5700k einstellbar	1800lm- 1960lm	IP54	82.64 / 89.00
SPA-AR18-D	18 Watt	LED Aufbauleuchten Round, Ø280mm H48, weiss, <b>dimmbar</b> , Phasenabschnitt	85	3000K/4000K 5700k einstellbar	1800lm- 1960lm	IP54	91.92 / 99.00
SPA-AR18-S	18 Watt	LED Aufbauleuchten Round, Ø280mm H48mm, weiss, <b>SENSOR</b>	85	3000K/4000K 5700k einstellbar	1800lm 1960lm	IP54	101.21 / 109.00
SPA-AR18-N	18 Watt	LED Aufbauleuchten Round, Ø280mm H48, weiss, <b>NOTLICHT</b>	85	3000K/4000K 5700k einstellbar	1800lm- 1960lm	IP54	CHF a.A

### LED Aufbauleuchten Round 330x48mm

on/off / dimmbar / Bewegungsmelder / NOTLICHT

ART. NR.	WATT	BEZEICHNUNG	Ra/CRI	KELVIN	LICHTSTROM	IP	PREIS CHF exkl. / inkl. MWSt
SPA-AR250	25 Watt	LED Aufbauleuchten Round, Ø330mm H48mm, weiss, <b>on/off</b>	85	3000K/4000K 5700k einstellbar	2500lm- 2750lm	IP54	119.78 / 129.00
SPA-AR250-D	25 Watt	LED Aufbauleuchten Round, Ø330mm H48, weiss, <b>dimmbar</b> Phasenabschnitt	85	3000K/4000K 5700k einstellbar	2500lm- 2750lm	IP54	138.35 / 149,00
SPA-AR250-S	25 Watt	LED Aufbauleuchten Round, Ø330mm H48mm, weiss, <b>SENSOR</b>	85	3000K/4000K 5700k einstellbar	2500lm- 2750lm	IP54	147.63 / 159.00
SPA-AR250-N	25 Watt	LED Aufbauleuchten Round, Ø330mm H48, weiss, <b>NOTLICHT</b>	85	3000K/4000K 5700k einstellbar	2500lm- 2750lm	IP54	CHF a.A.
SPA-AR250-NS	25 Watt	LED Aufbauleuchten Round, Ø330mm H48mm, weiss, <b>NOTLICHT, SENSOR</b>	85	3000K/4000K 5700k einstellbar	2500lm- 2750lm	IP54	CHF a.A
SPA-AR250-DA	25 Watt	LED Aufbauleuchten Round, Ø330mm H48, weiss, <b>DALI</b>	85	3000K/4000K 5700k einstellbar	2500lm- 2750lm	IP54	CHF a.A.

Grössere Mengen auf Anfrage. Preisänderungen vorbehalten. April 2019



## PREISLISTE

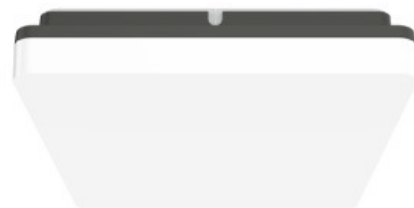
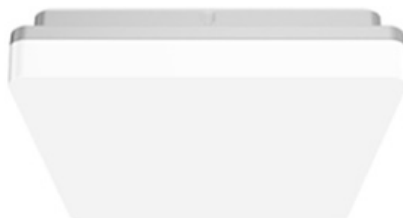
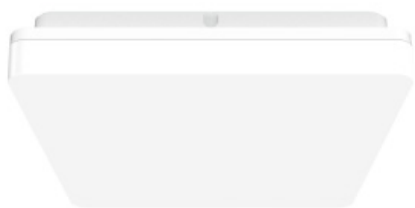

### LED Aufbauleuchten Square 280x280mm

on/off / Bewegungsmelder

ART. NR.	WATT	BEZEICHNUNG	Ra/CRI	KELVIN	LICHTSTROM	IP	PREIS CHF exkl. / inkl. MWSt
SPA-ASQ18	18 Watt	LED Aufbauleuchten Square, 280x280mm H48mm, weiss, <b>on/off</b>	85	3000K/4000K 5700k einstellbar	1800lm- 1960lm	IP54	82.64 / 89.00
SPA-ASQ18-S	18 Watt	LED Aufbauleuchten Square, 280x280mm H48mm, weiss, <b>SENSOR</b>	85	3000K/4000K 5700k einstellbar	1800lm- 1960lm	IP54	101.21 / 109.00

### LED Aufbauleuchten Square 330x330mm

on/off / Bewegungsmelder

ART. NR.	WATT	BEZEICHNUNG	Ra/CRI	KELVIN	LICHTSTROM	IP	PREIS CHF exkl. / inkl. MWSt
SPA-ASQ-25	25 Watt	LED Aufbauleuchten Square, 330x330mm H48mm, weiss, <b>on/off</b>	85	3000K/4000K 5700k einstellbar	2000lm 2200lm	IP54	119.78 / 129.00
SPA-ASQ-25-S	25 Watt	LED Aufbauleuchten Square, 330x330mm H48mm, weiss, <b>SENSOR</b>	85	3000K/4000K 5700k einstellbar	2500lm 2750lm	IP54	147.63 / 159.00

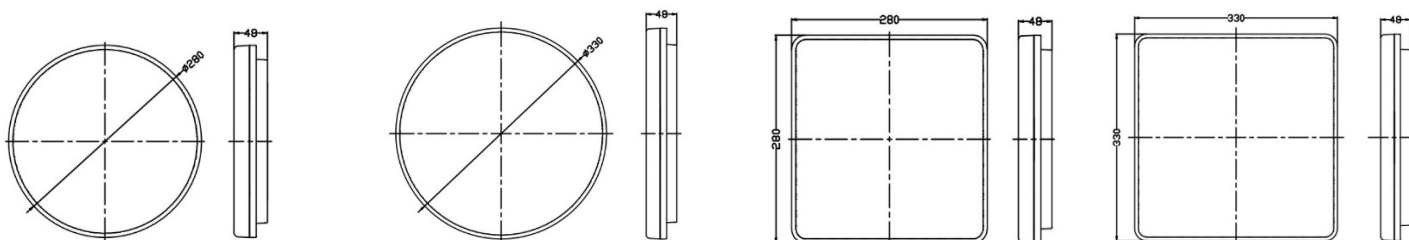

Grössere Mengen auf Anfrage. Preisänderungen vorbehalten. April 2019



Spatalux GmbH  
 Spechtweg 6  
 CH-8032 Zürich

T +41 (0)44 586 98 90  
 F +41 (0)43 888 42 75  
 info@spatalux.ch  
 www.spatalux.ch



## PREISLISTE



### LED-Aufbauleuchte 12W 3000K/4000K einstellbar Ø250x58mm / on/off / Weiss oder Schwarz / IP65

ART. NR.	WATT	BEZEICHNUNG	Ra/CRI	KELVIN	LICHTSTROM	IP	PREIS CHF exkl. / inkl. MWSt
SPA-30201sz SPA-30209ws	12 Watt	LED-Aufbauleuchte on/off <b>Vollmond</b> Abstrahlwinkel 110° Aluminium + Kunststoff IK10 Gehäuse: schwarz / weiss	80	3000K / 4000K einstellbar	1050-1250lm	IP65	129.06 / 139.00
SPA-30202sz SPA-30213ws	12 Watt	LED-Aufbauleuchte on/off <b>halbmond</b> Abstrahlwinkel 110° Aluminium + Kunststoff IK10 Gehäuse: Schwarz / Weiss	80	3000K / 4000K einstellbar	1050-1250lm	IP65	129.06 / 139.00

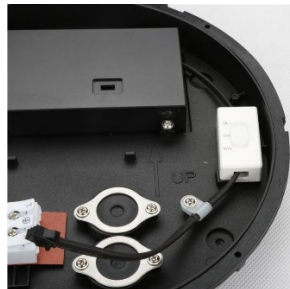

Preise exkl. MWST. Grössere Mengen auf Anfrage. Preisänderungen vorbehalten. Oktober 2021



## PREISLISTE



SPA-002W



SPA-003W



SPA-004W

### LED Wand-/Deckenleuchte Aluminium, IP65

on/off / Bewegungsmelder / Notfall Batterie, 280x78mm

ART. NR.	WATT	BEZEICHNUNG	Ra/CRI	KELVIN	LICHTSTROM	IP	PREIS CHF exkl. / inkl. MWSt
SPA-002W SPA-003W SPA-004W	10 Watt	LED Wand-/Deckenleuchte dimmbar, on/off, 280x78mm Gehäuse: schwarz / weiss	80	3000K / 4000K 5000K	800lm	IP65	162.49 / 175.00
SPA-002WS SPA-003WS SPA-004WS	10 Watt	LED Wand-/Deckenleuchte dimmbar, SENSOR, 280x78mm Gehäuse: schwarz / weiss	80	3000K / 4000K 5000K	800lm	IP65	171.77 / 185.00
SPA-002WE SPA-003WE SPA-004WE	10 Watt	LED Wand-/Deckenleuchte dimmbar, Notfall Batterie 3h, 280x78mm Gehäuse: schwarz / weiss	80	3000K / 4000K 5000K	800lm	IP65	184.77 / 199.00
SPA-002WSE SPA-003WSE SPA-004WSE	10 Watt	LED Wand-/Deckenleuchte dimmbar, SENSOR Notfall Batterie 3h, 280x78mm Gehäuse: schwarz / weiss	80	3000K / 4000K 5000K	800lm	IP65	CHF a/A

### LED Wand-/Deckenleuchte Aluminium, IP65

on/off / Bewegungsmelder / Notfall Batterie, 280x78mm

ART. NR.	WATT	BEZEICHNUNG	Ra/CRI	KELVIN	LICHTSTROM	IP	PREIS CHF exkl. / inkl. MWSt
SPA-002W SPA-003W SPA-004W	20 Watt	LED Wand-/Deckenleuchte dimmbar, on/off, 280x78mm Gehäuse: schwarz / weiss	80	3000K / 4000K 5000K	1600lm	IP65	171.77 / 185.00
SPA-002WS SPA-003WS SPA-004WS	20 Watt	LED Wand-/Deckenleuchte dimmbar, SENSOR, 280x78mm Gehäuse: schwarz / weiss	80	3000K / 4000K 5000K	1600lm	IP65	181.06 / 195.00
SPA-002WE SPA-003WE SPA-004WE	20 Watt	LED Wand-/Deckenleuchte dimmbar, Notfall Batterie 3h, 280x78mm Gehäuse: schwarz / weiss	80	3000K / 4000K 5000K	1600lm	IP65	194.06 / 209.00
SPA-002WSE SPA-003WSE SPA-004WSE	20 Watt	LED Wand-/Deckenleuchte dimmbar, SENSOR Notfall Batterie 3h, 280x78mm Gehäuse: schwarz / weiss	80	3000K / 4000K 5000K	1600lm	IP65	CHF a/A

Grössere Mengen auf Anfrage. Preisänderungen vorbehalten. Oktober 2018



## PREISLISTE



### LED-Balkenleuchte 1195mm - L1195xB56xH68mm

Ein/Aus / Notlicht 3h / DALI / DALI Notlicht - Netzteil: Philips

ART. NR.	WATT	BEZEICHNUNG	Ra/CRI	KELVIN	LICHTSTROM	IP	PREIS CHF exkl. / inkl. MWSt
SPA-40010	20/25/35/40W einstellbar	LED-Balkenleuchte, 130° weiss, 5 J. Garantie, <b>on/off</b>	80	3000K/4000K 5000K einstellbar	2800/3500lm 4200/4900lm	IP20	64.07 / 69.00
SPA-40011	20/25/35/40W einstellbar	LED-Balkenleuchte, 130° weiss, 5 J. Garantie, <b>Not 3h</b>	80	3000K/4000K 5000K einstellbar	2800/3500lm 4200/4900lm	IP20	147.63 / 159.00
SPA-40014	20/25/35/40W* einstellbar	LED-Balkenleuchte, 130°, weiss, 5 J. Garantie, <b>DALI</b>	80	3000K/4000K 5000K einstellbar	2800/3500lm 4200/4900lm	IP20	129.06 / 139.00
SPA-40015	20/25/35/40W* einstellbar	LED-Balkenleuchte, 130° weiss, 5 J. Garantie <b>DALI Not</b>	80	3000K/4000K 5000K einstellbar	2800/3500lm 4200/4900lm	IP20	212.63 / 229.00
SPA-40020	20/25/35/40W einstellbar	LED-Balkenleuchte, 130°, <b>schwarz</b> , 5 J. Garantie <b>on/off</b>	80	3000K/4000K 5000K einstellbar	2800/3500lm 4200/4900lm	IP20	73.35 / 79.00
SPA-40021	20/25/35/40W einstellbar	LED-Balkenleuchte, 130° <b>schwarz</b> , 5 J. Garantie <b>Not 3h</b>	80	3000K/4000K 5000K einstellbar	2800/3500lm 4200/4900lm	IP20	156.92 / 169.00

### LED-Balkenleuchte 1450mm - L1450xB56xH68mm

Ein/Aus / Notlicht 3h / DALI / DALI Notlicht - Netzteil: Philips

ART. NR.	WATT	BEZEICHNUNG	Ra/CRI	KELVIN	LICHTSTROM	IP	PREIS CHF exkl. MWST
SPA-40012	27/34/42/50W einstellbar	LED-Balkenleuchte, 130° weiss, 5 J. Garantie, <b>on/off</b>	80	3000K/4000K 5000K einstellbar	3780/4760lm 5880/7000lm	IP20	82.64 / 89.00
SPA-40013	27/34/42/50W einstellbar	LED-Balkenleuchte, 130° weiss, 5 J. Garantie, <b>Not 3h</b>	80	3000K/4000K 5000K einstellbar	3780/4760lm 5880/7000lm	IP20	166.20 / 179.00
SPA-40016	27/34/42/50W* einstellbar	LED-Balkenleuchte, 130° weiss, 5 J. Garantie, <b>DALI</b>	80	3000K/4000K 5000K einstellbar	3780/4760lm 5880/7000lm	IP20	156.92 / 169.00
SPA-40017	27/34/42/50W* einstellbar	LED-Balkenleuchte, 130° weiss, 5 J. Garantie, <b>DALI Not</b>	80	3000K/4000K 5000K einstellbar	3780/4760lm 5880/7000lm	IP20	240.48 / 259.00

ART. NR.	BEZEICHNUNG	PREIS CHF exkl. / inkl. MWSt
SPA-40035	Seilpendel-Set 2m (2 Stück)	11.61 / 12.50
SPA-40036	Installationsclips (2 Stück)	3.25 / 3.50

\*Bei den DALI Leuchten muss die Leistung vorab bestimmt werden! Bitte geben Sie dies bei Ihrer Bestellung an. / Alle Preise verstehen sich exkl. Gesetzlicher Mehrwertsteuer.

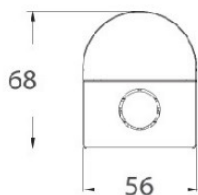

Preisänderungen vorbehalten. April 2021



Spatalux GmbH  
 Spechtweg 6  
 CH-8032 Zürich

T +41 (0)44 586 98 90  
 F +41 (0)43 888 42 75  
 info@spatalux.ch  
 www.spatalux.ch





## PREISLISTE



### LED Röhren T8 >Pro- & Power Serie<

ART. NR.	WATT	BEZEICHNUNG	Ra/CRI	KELVIN	LICHTSTROM	IP	PREIS CHF exkl. / inkl. MWSt
<b>SPA-F12B-830</b> <b>SPA-F12B-840</b>	20 Watt	LED Röhre « <b>PRO Serie</b> » 130lm/W, 2600lumen, Matt, inkl. Starter, Fassung G13, T8 <b>120cm</b>	80	<b>3000K</b> <b>4000K</b>	<b>2600lm</b>	IP20	14.76 / 15.90
<b>SPA-420-860</b> SPA-420-840 SPA-420-830	20 Watt	LED Röhre « <b>Power Serie</b> » 160lm/W, 3200lumen, Matt, inkl. Starter, Fassung G13, T8 <b>120cm</b>	80	<b>6000K</b> 4000K* 3000K*	<b>3200lm</b>	IP20	20.89 / 22.50
<b>SPA-520-860</b> <b>SPA-520-840</b> SPA-520-830	30 Watt	LED Röhre « <b>Power Serie</b> » 160lm/W, 4600lumen, Matt, inkl. Starter, Fassung G13, T8 <b>150cm</b>	80	<b>6000K</b> <b>4000K</b> <b>5000K</b> 3000K*	<b>4600lm</b>	IP20	27.76 / 29.90
SPA-F43B-830 <b>SPA-F43B-840</b> SPA-F43B-860	8 Watt	LED Röhre « <b>PRO Serie</b> » 130lm/W, 1040lumen, Matt, inkl. Starter, Fassung G13, T8 <b>43cm</b> (436mm)	80	<b>3000K</b> <b>4000K</b> <b>5000K</b> 6000K*	<b>1040lm</b>	IP20	22.19 / 23.90
SPA-F97B-830 SPA-F97B-840 SPA-F97B-860	12 Watt	LED Röhre « <b>PRO Serie</b> » 130lm/W, 3200lumen, Matt, inkl. Starter, Fassung G13, T8 <b>97cm</b> (976mm)	80	3000K* <b>4000K</b> 6000K*	<b>1560lm</b>	IP20	26.93 / 29.00

Lieferumfang: LED Röhre und LED Starter

### EVG LED Röhren T8 >Power Serie<

ART. NR.	WATT	BEZEICHNUNG	Ra/CRI	KELVIN	LICHTSTROM	IP	PREIS CHF exkl. / inkl. MWSt
EVG-420-860 <b>EVG-420-840</b> EVG-420-830	20 Watt	LED Röhre « <b>Power Serie</b> » 160lm/W, 3200lumen, Matt, Fassung G13, T8, geeignet für elektronische Vorschaltgeräte <b>120cm</b>	80	6000K* <b>4000K</b> 3000K*	<b>3200lm</b>	IP20	25.91 / 27.90
EVG-520-860 <b>EVG-520-840</b> EVG-520-830	30 Watt	LED Röhre « <b>Power Serie</b> » 160lm/W, 4600lumen, Matt, Fassung G13, T8, geeignet für elektronische Vorschaltgeräte <b>150cm</b>	80	6000K* <b>4000K</b> 3000K*	<b>4600lm</b>	IP20	33.33 / 35.90

\* = nicht lagernd, 2-3 Wochen Lieferfrist

Preise exkl. MWST. Grössere Mengen auf Anfrage. Preisänderungen vorbehalten. April 2021



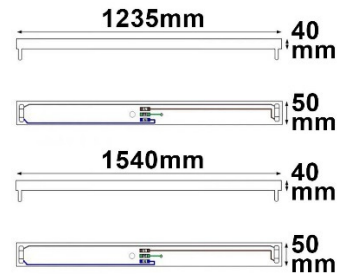

## Armatür für LED-Röhren T8

G13 Sockel beidseitig vorverdrahtet, inkl. 3pol Anschlussklemme (L-N-PE)

ART. NR.	BEZEICHNUNG	Masse LxBxH	IP	PREIS CHF exkl. / inkl. MWSt
SPA-113287	120cm Armatür für LED-Röhren T8 Verkabelt, ohne VG, 0-260V Sockeltyp: G13, Aluminium, weiss	1235x50x40mm	IP20	15.62 / 17.90
SPA-113288	150cm Armatür für LED-Röhren T8 Verkabelt, ohne VG, 0-260V Sockeltyp: G13, Aluminium, weiss	1540x50x40mm	IP20	21.26 / 22.90

ACHTUNG: Halterung nicht geeignet für Leuchtstoffröhren!



## Feuchtraumleuchte Gehäuse 120/150cm 1xT8 G13, Grau IP65

ohne Leuchtmittel - Kaskadierbar – vorbereitet für Serieninstallation

ART. NR.	BEZEICHNUNG	Masse LxBxH	IP	PREIS CHF exkl. / inkl. MWSt
SPA- 1152544	120cm Feuchtraumleuchte Gehäuse für LED-Röhren T8, Verkabelt, ohne VG, 0-230V Sockeltyp: G13, Kunststoff ABS, grau mit Edelstahlklammern, transparenter Diffusor aus Polystyrol - Für Stalleinrichtungen – Ammoniak beständig	1270x75x90mm	IP65	42.62 / 45.90
SPA-1152545	150cm Feuchtraumleuchte Gehäuse für LED-Röhren T8, Verkabelt, ohne VG, 0-230V Sockeltyp: G13, Kunststoff ABS, grau mit Edelstahlklammern, transparenter Diffusor aus Polystyrol - Für Stalleinrichtungen – Ammoniak beständig	1560x75x90mm	IP65	50.05 / 53.90

ACHTUNG: Halterung nicht geeignet für Leuchtstoffröhren!

Preise exkl. MWST. Grössere Mengen auf Anfrage. Preisänderungen vorbehalten. OKT. 2021



## PREISLISTE



### LED Linearleuchte IP65 / Stossfestigkeit IK08

ART. NR.	WATT	BEZEICHNUNG	Ra/CRI	KELVIN	LICHTSTROM	IP	PREIS CHF exkl. / inkl. MWSt
<b>SPA-066T</b>	30 Watt	<b>LED Linearleuchte IP65</b> 120lm/W, matt, 1200x54x53mm beidseitige Anschlüsse, anreihbar	80	3000K* <b>4000K</b> 5000K* 6500K*	<b>3600lm</b>	IP65	54.78 / 59.00
<b>SPA-066T-15</b>	40 Watt	<b>LED Linearleuchte IP65</b> 120lm/W, matt, 1500x54x53mm beidseitige Anschlüsse, anreihbar	80	3000K* 4000K* 5000K* 6500K*	<b>4800lm</b>	IP65	82.64 / 89.00
<b>SPA-066SE</b>	1.5m	<b>Seilaufhängung 1,5m</b> 2 Stück Stahlkabel/Baldachin für Deckenabhängung, Edelstahl					6.41 / 6.90

\* = nicht lagernd, 2-3 Wochen Lieferfrist

Beidseitig schraubenlose Schnellmontage-Steckklammern zum Aneinanderreihen von bis zu 25 Leuchten, inkl. Zwei Metall-Montageklammern + Schrauben + Dübel Stossfestigkeit IK08

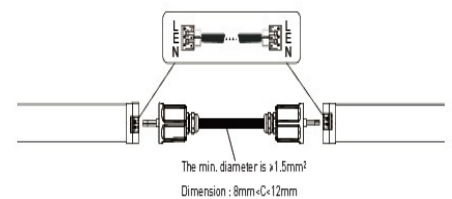

Preise exkl. MWST. Grössere Mengen auf Anfrage. Preisänderungen vorbehalten. August 2019



Spatalux GmbH  
 Spechtweg 6  
 CH-8032 Zürich

T +41 (0)44 586 98 90  
 F +41 (0)43 888 42 75  
 info@spatalux.ch  
 www.spatalux.ch



## PREISLISTE BRUTTO

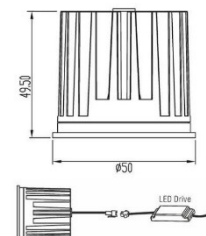

### HeloLite LED Module, inkl. Netzteil dimmbar Phasen Ab- & Anschnitt

ART. NR.	WATT	BEZEICHNUNG	Ra/CRI	KELVIN	LICHTSTROM	IP	PREIS CHF exkl. / inkl. MWSt
SPA-011M	9 Watt	LED Modul, inkl. Netzteil	90	2700K	690lm	IP20	44.57 / 48.00
		49.5xØ50mm, (15°/24°/60°) 40° dimmbar Phasen Ab-/Anschnitt		3000K	780lm		
				4000K*	840lm		
SPA-011M	11 Watt	LED Modul, inkl. Netzteil	90	2700K*	900lm	IP20	50.14 / 54.00
		75xØ50mm, (15°/24°/60°) 40° dimmbar Phasen Ab-/Anschnitt		3000K*	950lm		
				4000K*	1050lm		



011-M-075/090-C

M02-090-C

650004

650002

650003

650001

650005

### Deckeneinbauringe

ART. NR.	BEZEICHNUNG	Farben	Bohrloch	PREIS CHF exkl. / inkl. MWSt
011M-075	Ø84mm gerundet, schwenkbar	weiss matt/ (schwarz matt)	Ø72-75mm	9.19 / 9.00
011M-090-C	Ø104mm gerundet, schwenkbar	weiss matt/ (schwarz matt)	Ø90mm	11.98 / 12.90
M02-090-C	Ø100cm gerundet	weiss matt/ (schwarz matt)	Ø90mm	14.58 / 15.70
650001	Ø82mm mit Frontaustritt, schwenkbar	Silber	Ø68-72mm	12.91 / 13.90
650003		Silb. Gebürstet		
650002		Chrom		
650004		Weiss		
650005		Schwarz matt		
920829109	Einbaugehäuse ThermoX® Dekorblende Außendurchmesser Ø 125 mm Öffnungsmaß Ø 68 / 75 mm	Weiss	Ø68-75mm	16.63 / 17.90
920829309		Mattnickel		30.55 / 32.90
920829209		Chrom		30.55 / 32.90

\* = nicht lagernd, 2-3 Wochen Lieferfrist

Preise exkl. MWST. Grössere Mengen auf Anfrage. Preisänderungen vorbehalten. JANUAR 2020



## PREISLISTE



### LED-Downlight 3000/4000/5700K einstellbar DALI PUSH-Dimmbar – Schutzklasse II

ART. NR.	WATT	BEZEICHNUNG	Ra/CRI	KELVIN	LICHTSTROM	IP	PREIS CHF exkl. / inkl. MWST
SPA-12024-DA	10 Watt	<b>LED-Downlight weiss</b> ALU-Druckguss, Ø145x77mm Bohrloch 125-135mm Abstrahlwinkel 75° Dimmbar DALI Push-dim	80	3000K/4000K/ 5700K einstellbar	920-1000lm	IP54	110.49 / 119.00
SPA-12025-DA	18 Watt	<b>LED-Downlight weiss</b> ALU-Druckguss, Ø172x90mm Bohrloch 150-165mm Abstrahlwinkel 75° Dimmbar DALI Push-dim	80	3000K/4000K/ 5700K einstellbar	1600-1800lm	IP54	119.78 / 129.00
SPA-12026-DA	25 Watt	<b>LED-Downlight weiss</b> ALU-Druckguss, Ø228x207mm Bohrloch 200-210mm Abstrahlwinkel 75° Dimmbar DALI Push-dim	80	3000K/4000K/ 5700K einstellbar	2600-2800lm	IP54	156.92 / 169.00
SPA-12027-DA	35 Watt	<b>LED-Downlight weiss</b> ALU-Druckguss Ø280x123mm Bohrloch 230-260mm Abstrahlwinkel 75° Dimmbar DALI Push-dim	80	3000K/4000K/ 5700K einstellbar	3600-3800lm	IP54	184.77 / 199.00

Einbetoniergehäuse auf Anfrage erhältlich!



Preise exkl. MWST. Grössere Mengen auf Anfrage. Preisänderungen vorbehalten. August 2021



Spatalux GmbH  
 Spechtweg 6  
 CH-8032 Zürich

T +41 (0)44 586 98 90  
 F +41 (0)43 888 42 75  
 info@spatalux.ch  
 www.spatalux.ch



## PREISLISTE

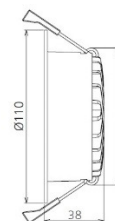
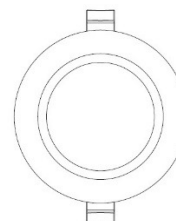

### LED Deckeneinbauleuchte, inkl. Netzteil dimmbar Phasen Ab- & Anschnitt

ART. NR.	WATT	BEZEICHNUNG	Ra/CRI	KELVIN	LICHTSTROM	IP	PREIS CHF exkl. / inkl. MWSt
SPA-97DL3-D weiss	10 Watt	LED Downlight, inkl. Netzteil 230mA, Ø110x38mm, 90° DIM Phasenabschnitt/-anschnitt Bohrloch: Ø90-95mm	80	2700K* 3000K 4000K*	790lm 890lm 990lm	IP54	44.57 / 48.00

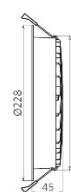
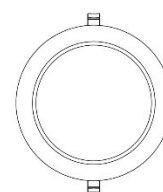
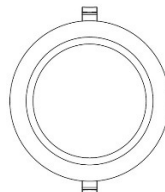

ART. NR.	WATT	BEZEICHNUNG	Ra/CRI	KELVIN	LICHTSTROM	IP	PREIS CHF exkl. / inkl. MWSt
SPA-97DL6-D weiss	25 Watt	LED Downlight, inkl. Netzteil 600mA, Ø190x45mm, 90° DIM Phasenabschnitt/-anschnitt Bohrloch: Ø160-170mm	80	2700K* 3000K* 4000K*	2300lm 2500lm 2750lm	IP54	57.57 / 62.00
SPA-97DL8-D weiss	35 Watt	LED Downlight, inkl. Netzteil 800mA, Ø228-45mm, 90° DIM Phasenabschnitt/-anschnitt Bohrloch: Ø200-210mm	80	2700K* 3000K* 4000K*	3300lm 3500lm 3800lm	IP54	72.43 78.00

\* = nicht lagernd, 2-3 Wochen Lieferfrist

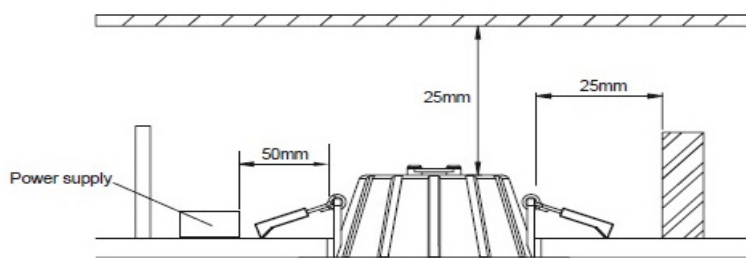

Preise exkl. MWST. Grössere Mengen auf Anfrage. Preisänderungen vorbehalten. JANUAR 2020



## PREISLISTE

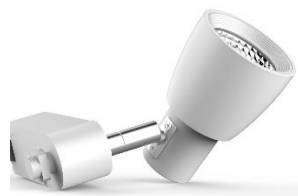

### 3-Phasen oder 1-Phasen LED Strahler 10W dimmbar dimmbar Phasen Ab- & Anschnitt

ART. NR.	WATT	BEZEICHNUNG	Ra/CRI	KELVIN	LICHTSTROM	IP	PREIS CHF exkl. / inkl. MWSt
SPA-014TL-3PH SPA-014TL-1PH* Weiss/Schwarz	10 Watt	LED Strahler - Netzteil integriert Ø65x97.5x145mm, 45°, 50Hz, AC200-240V, Schutzklasse I DIM Phasenabschnitt/-anschnitt	80	2700K* 3000K 4000K*	700lm 750lm 800lm	IP20	82.64 / 89.00

### Deckenmontage LED Strahler 10W dimmbar dimmbar Phasen Ab- & Anschnitt

ART. NR.	WATT	BEZEICHNUNG	Ra/CRI	KELVIN	LICHTSTROM	IP	PREIS CHF exkl. / inkl. MWSt
SPA-014TL-D Weiss/Schwarz	10 Watt	LED Strahler - Netzteil integriert Ø65x97.5x145mm, 45°, 50Hz, AC200-240V, Schutzklasse I DIM Phasenabschnitt/-anschnitt	80	2700K* 3000K* 4000K*	700lm 750lm 850lm	IP20	82.64 / 89.00

\* = nicht lagernd, 2-3 Wochen Lieferfrist

Auf Anfrage auch in 90CRI verfügbar Lumen bei 3000K – 650lm

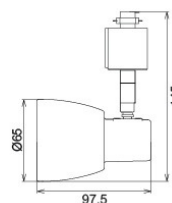
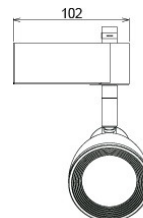

Kompatibel: Mit allen gängigen 3-Phasen Stromschienen wie EUTRAC, GLOBAL, IVELA, IKEA SKENINGE, Stucchi, ERCO

Wir bieten auch 3-Phasen Schienen in unserem Sortiment an. Fragen Sie nach unserer Preisliste. Wir beraten Sie gerne.

Grössere Mengen auf Anfrage. Preisänderungen vorbehalten. JANUAR 2020



## Preisliste

### LED 9.6W, CRI80 Strips, 24V, IP20

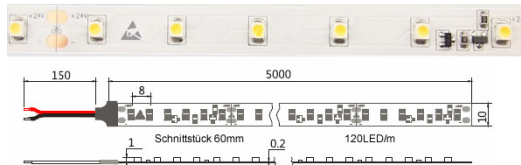

ART. NR.	WATT	Spezifikationen	Ra/CRI	KELVIN	LICHTSTROM	IP	PREIS CHF inkl. MWSt / 5m
SPA-3528A60	9,6 Watt	93lm/W, 24V, 120LEDs/m, dimmbar, Schnitt-Stück 60mm, Abstand LEDs 8mm, Breite 8mm, Höhe 2mm, CV = constant voltage	80	2700K/3000K/ 4000K/6500K	900lm 950lm 1000lm 1100lm	IP20	<b>33.90</b> statt 79.00

### LED 18W, CRI90/99 Strips, 24V, IP20

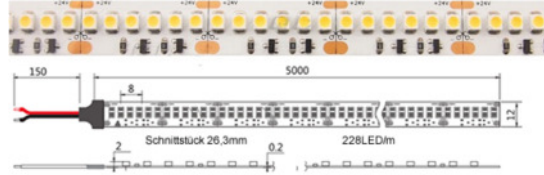

ART. NR.	WATT	BEZEICHNUNG	Ra/CRI	KELVIN	LICHTSTROM	IP	PREIS CHF inkl. MWSt / 5m
SPA-3528A114	18 Watt	89lm/W, 24V, 228LEDs/m, dimmbar, Schnitt-Stück 26.3mm, Abstand LEDs 4.4mm, Breite 12mm, Höhe 2mm, <b>CC</b> , <b>IC = integrated circuit</b>	90	2700K/3000K/ 4000K/6500K	1600lm 1650lm 1700lm 1800lm	IP20	<b>129.00</b> statt 183.00
SPA-3528A114-FS	18 Watt	83lm/W, 24V, 228LEDs/m, dimmbar, Schnitt-Stück 26.3mm, Abstand LEDs 4.4mm, Breite 12mm, Höhe 2mm, <b>CC</b> , <b>IC = integrated circuit</b>	99	2700K/3000K/ 4000K/6500K	1500lm 1550lm 1600lm 1700lm	IP20	<b>132.30</b> statt 189.00

### LED 22W, CRI80 Strips, 24V, IP20

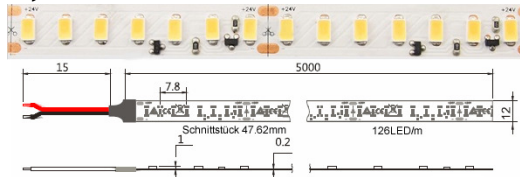

ART. NR.	WATT	BEZEICHNUNG	Ra/CRI	KELVIN	LICHTSTROM	IP	PREIS CHF inkl. MWSt / 5m
SPA-5630A63	22 Watt	127lm/W, 24V, 126LEDs/m, dimmbar, Schnitt-Stück 56mm, Abstand LEDs 8mm, Breite 12mm, Höhe 2mm, <b>CC</b> , <b>IC = integrated circuit</b> einheitliche Helligkeit bis 5m	80	2700K/3000K/ 4000K/6000K	2800lm 2850lm 2900lm 3000lm	IP20	<b>159.00</b> statt 229.00





## LED 7W/15W, RGB Strips, 24V, IP20



ART. NR.	WATT	BEZEICHNUNG	Ra/CRI	KELVIN	LICHTSTROM	IP	PREIS CHF inkl. MWSt / 5m
RGB-5050A15	7,2 W	36lm/W, 24V, 30LEDs/m, dimmbar, Schnitt-Stück 10cm, Abstand LEDs 33mm, Breite 10mm, Höhe 2mm, CV	RGB		230lm	IP20	45.90 statt 79.00
RGB-5050A30	14,4 W	30lm/W, 24V, 60LEDs/m, dimmbar, Schnitt-Stück 10cm, Abstand LEDs 17mm, Breite 10mm, Höhe 2mm, CV	RGB		450lm	IP20	119.00

## LED RGBW 23W, CRI90 Strips, 24V, IP20

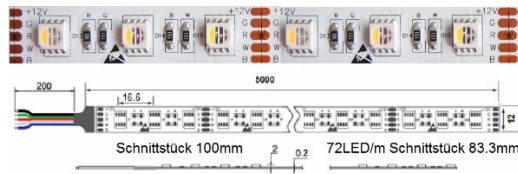
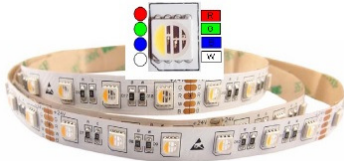

ART. NR.	WATT	BEZEICHNUNG	Ra/CRI	KELVIN	LICHTSTROM	IP	PREIS CHF inkl. MWSt / 5m
RGBW-5050A36CX4	23 Watt	57lm/W, 24V, 72LEDs/m, dimmbar, Schnitt-Stück 100mm, Abstand LEDs 14.2mm, Breite 12mm, Höhe 2mm, CV <b>4in1 Chip Technologie</b>	90	2700K/3000K/ 4000K/6500K Rot: 620-630 blau:465-470 grün: 520-525 gelb: 590-595	1000lm 1050lm 1100lm 1150lm	IP20	145.00

## LED WRGBP 24W, CRI80 Strips, 24V, IP20 – NEUHEIT!

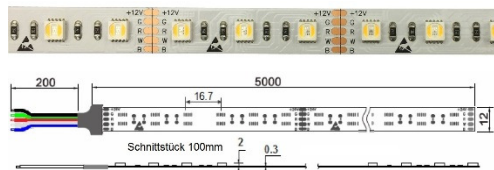

ART. NR.	WATT	BEZEICHNUNG	Ra/CRI	KELVIN	LICHTSTROM	IP	PREIS CHF inkl. MWSt / 5m
SPA-F5050WCP	24 Watt	54lm/W, 24V, 60LEDs/m, dimmbar, Schnitt-Stück 100mm, Abstand LEDs 16.7mm, Breite 12mm, Höhe 2mm, CV <b>5in1 Chip Technologie</b>	80	2600K-RGB- 6000K Rot: 620-625 blau:465-470 grün: 520-525 gelb: 590-595	1200lm 1250lm 1300lm 1370lm	IP20	109.00 statt 159.00

Preise exkl. MWST. Grössere Mengen auf Anfrage. Preisänderungen vorbehalten. April 2021



## Preisliste



### “Eaglerise” Netzteile 5 Jahre Garantie

#### Konstantspannung-LED-Treiber

ART. NR.	WATT	Spezifikationen	VDC	Power Faktor	Ausgangs-Strom	IP	PREIS CHF exkl. / inkl. MWSt
LS-30-24 LI nicht dimmbar	30 W	Eingangsspan.: 176-264Vac Betriebstemp.: -10°C - +45°C, 47-63Hz, Wirkungsgrad 87% Masse: <b>L142xB45xH30mm</b>	24V	≥0.9 bei Volllast	1.25A	IP20	22.19 / 23.90
LS-60-24 LI nicht dimmbar	60 W	Eingangsspan.: 176-264Vac Betriebstemp.: -10°C - +45°C, 47-63Hz, Wirkungsgrad 87% Masse: <b>L170xB45xH30mm</b>	24V	≥0.9 bei Volllast	2.5A	IP20	30.55 / 32.90
EDP100V0240LS nicht dimmbar	100 W	Eingangsspan.: 176-264Vac Betriebstemp.: -10°C - +45°C, 47-63Hz, Wirkungsgrad 87% Masse: <b>L230xB60xH35mm</b>	24V	≥0.9 bei Volllast	4.2A	IP20	54.78 / 59.00



### “Tridonic” LC Netzteile 5 Jahre Garantie

#### Konstantspannung-LED-Treiber

ART. NR.	WATT	BEZEICHNUNG	VDC	Power Faktor	Ausgangs-strom	IP	PREIS CHF exkl. / inkl. MWSt
87500853 nicht dimmbar	35 W	Eingangsspan.: 198-264Vac Betriebstemp.: -20°C - +50°C, 50-60Hz, Wirkungsgrad 86,5% Masse: <b>L142xB43xH30mm</b>	24V	0.95	1.76A	IP20	31.48 / 33.90
87500667 nicht dimmbar	60 W	Eingangsspan.: 198-264Vac Betriebstemp.: -20°C - +50°C, 50-60Hz, Wirkungsgrad 92% Masse: <b>L225xB43xH30mm</b>	24V	0.95	2.91A	IP20	41.69 / 44.90
87500668 nicht dimmbar	100 W	Eingangsspan.: 198-264Vac Betriebstemp.: -20°C - +50°C, 50-60Hz, Wirkungsgrad 92% Masse: <b>L295xB43xH30mm</b>	24V	0.98	4.86A	IP20	52.83 / 56.90
87500668 nicht dimmbar	200 W	Eingangsspan.: 198-264Vac Betriebstemp.: -20°C - +50°C, 50-60Hz, Wirkungsgrad 93% Masse: <b>L325xB43xH30mm</b>	24V	0.95	9.40A	IP20	91.92 / 99.00

Preise exkl./inkl. MWST. Grössere Mengen auf Anfrage. Preisänderungen vorbehalten. März 2020





## “Tridonic” LCA Netzteile one4all, DALI/Push

### Dimmbarer Konstantspannung-LED-Treiber – 5 Jahre Garantie

ART. NR.	WATT	BEZEICHNUNG	VDC	Power Faktor	Ausgangsstrom	IP	PREIS CHF exkl. / inkl. MWSt
28001662 dimmbar DALI/Push	35 W	Eingangsspan.: 198-264Vac Betriebstemp.: -25 °C - +50 °C, 50-60Hz, Wirkungsgrad 89% Dimmbereich 1-100% Masse: <b>L195xB43xH30,2mm</b>	24V	0.98	1.76A	IP20	79.75 / 85.90
28001663 dimmbar DALI/Push	60 W	Eingangsspan.: 198-264Vac Betriebstemp.: -20 °C - +50 °C, 50-60Hz, Wirkungsgrad 93% Dimmbereich 1-100% Masse: <b>L225xB43xH30,2mm</b>	24V	0.98	2.95A	IP20	94.71 / 102.00
28001253 dimmbar DALI/Push	100 W	Eingangsspan.: 198-264Vac Betriebstemp.: -20 °C - +50 °C, 50-60Hz, Wirkungsgrad 93% Dimmbereich 1-100% Masse: <b>L295xB43xH30mm</b>	24V	0.99	4.68A	IP20	110.49 / 119.00
28001437 dimmbar DALI/Push	200 W	Eingangsspan.: 198-264Vac Betriebstemp.: -20 °C - +50 °C, 50-60Hz, Wirkungsgrad 93% Dimmbereich 1-100% Masse: <b>L325xB43xH29,8mm</b>	24V	0.99	7.1A	IP20	138.35 / 149.00

Preise exkl./Inkl. MWST. Grössere Mengen auf Anfrage. Preisänderungen vorbehalten. März 2020



## PREISLISTE

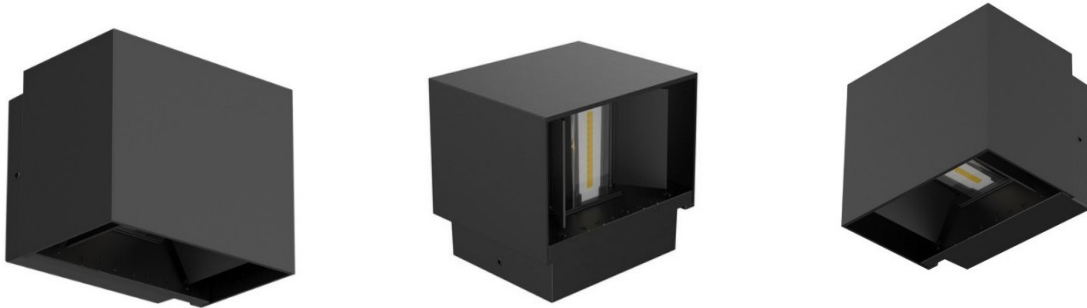

### LED-Wandleuchte 2x5Watt Winkel einstellbar Schwarz RAL9005

ART. NR.	WATT	BEZEICHNUNG	Ra/CRI	KELVIN	LICHTSTROM	IP	PREIS CHF exkl. / inkl. MWSt
SPA-WL20	2 x 5 Watt	LED-Wandleuchte schwarz 120x96.8x100mm, 15°-120° Aluminium, nicht dimmbar	80	3000K	2 x 450lm	IP65	101.21 / 109.00

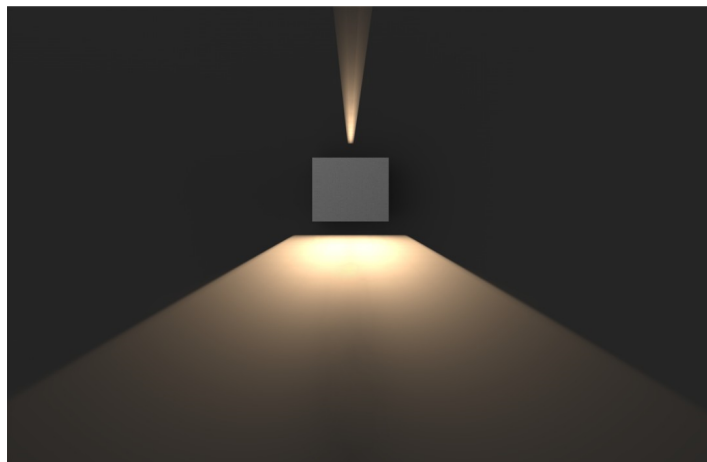
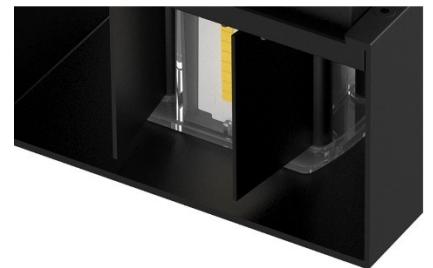
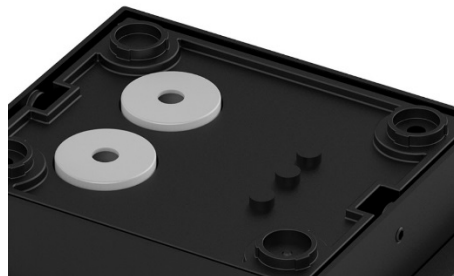
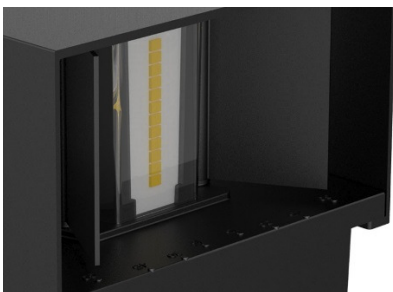

Preise exkl. MWST. Grössere Mengen auf Anfrage. Preisänderungen vorbehalten. April 2021



Spatalux GmbH  
Spechtweg 6  
CH-8032 Zürich

T +41 (0)44 586 98 90  
F +41 (0)43 888 42 75  
info@spatalux.ch  
www.spatalux.ch



## PREISLISTE

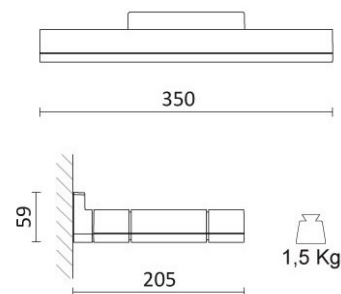

### LED Wandleuchte Wall Line – 2600lm 3000K

Made in Italy

ART. NR.	WATT	BEZEICHNUNG	Ra/CRI	KELVIN	LICHTSTROM	IP	PREIS CHF exkl. / inkl. MWSt
WallLine	30 Watt	LED Wandleuchte Wall Line Aluminium Druckguss, Polyester Netzteil im Gehäuse, Hz50/60, 230/240V, 1.5Kg, symmetrisch Abstrahlwinkel 110° für Indirekte Beleuchtung L350xB205H59mm	>80	3000K	2600lm	IP40	426.18 / 459.00

**Standard Farben:** matt weiss oder silber

**Einsatzbereich:** Hotels, Korridor / Flur, Eingangsbereiche, Hallen, Öffentliche und Private Räume

**Lieferfristen:** ca. 5 – 8 Arbeitstage



Preise exkl. MWST. Grössere Mengen auf Anfrage. Preisänderungen vorbehalten. August 2019



Spatalux GmbH  
 Spechtweg 6  
 CH-8032 Zürich

T +41 (0)44 586 98 90  
 F +41 (0)43 888 42 75  
 info@spatalux.ch  
 www.spatalux.ch



## PREISLISTE



### LED Strahler «Quader» 10W – 200W

Phasen Ab- & Anschnitt dimmbar

ART. NR.	WATT	BEZEICHNUNG	Ra/CRI	KELVIN	LICHTSTROM	IP	PREIS CHF exkl. / inkl. MWSt
22341	10W	LED Strahler «Quader» Bridgelux 45mil, 50/60Hz, 95-265V, 100-120° L179xB133xH57, 755g	80	2700K* 3000K 4000K* 5000K/6500K*	850-900lm	IP65	CHF a/A
22342	20W	LED Strahler «Quader» Bridgelux 45mil, 50/60Hz, 95-265V, 100-120° L201xB166xH77, 950g	80	2700K* 3000K* 4000K* 5000K/6500K*	1600- 1800lm	IP65	CHF a/A
22343	30W	LED Strahler «Quader» Bridgelux 45mil, 50/60Hz, 95-265V, 100-120° L215xB178xH81, 1.240kg	80	2700K 3000K 4000K* 5000K/6500K*	2400-3000lm	IP65	173.63 / 187.00
22344-Triack	50W	LED Strahler «Quader» Bridgelux 45mil, 50/60Hz, 95-265V, 100-120° L253xB194xH95, 1.830kg	80	2700K* 3000K 4000K* 5000K/6500K*	4000-5000lm	IP65	277.62 / 299.00
22346-Triack	100W	LED Strahler «Quader» Bridgelux 45mil, 50/60Hz, 95-265V, 100-120°, (2x50W) L340xB250xH116, 4.450kg	80	2700K* 3000K 4000K* 5000K/6500K*	8500-10000lm	IP65	491.18 / 529.00
22349-Triack	200W	LED Strahler «Quader» Bridgelux 45mil, 50/60Hz, 95-265V, 100-120°, (4x50W) L400x340xH192, 8.540kg	80	2700K* 3000K* 4000K* 5000K/6500K*	16000- 18000lm	IP65	649.03 / 699.00

\* = nicht lagernd, 2-3 Wochen Lieferzeit

Auf Wunsch können wir die LED Strahler «Quader» mit LED Chip (Bridgelux 45mil) mit Farbwiedergabeindex von über Ra90 ausrüsten. Sprechen Sie uns an. Wir beraten Sie gerne.

Die Strahler sind auch als 1-10V oder DALI sowie mit Fernbedienung und Funk-Taster verfügbar.

Preise inkl. MWST. Grössere Mengen auf Anfrage. Preisänderungen vorbehalten. Januar 2020



## PREISLISTE



### LED Strahler «Quader» 10W – 200W

nicht dimmbar

ART. NR.	WATT	BEZEICHNUNG	Ra/CRI	KELVIN	LICHTSTROM	IP	PREIS exkl. / inkl. MWSt
22301	10W	LED Strahler «Quader» Bridgelux 45mil, 50/60Hz, 95-265V, 100-120° L179xB133xH57, 755g	80	2700K* 3000K 4000K* 5000K/6500K*	850-900lm	IP65	39.83 / 42.90
22302	20W	LED Strahler «Quader» Bridgelux 45mil, 50/60Hz, 95-265V, 100-120° L201xB166xH77, 950g	80	2700K* 3000K 4000K* 5000K/6500K*	1600- 1800lm	IP65	73.35 / 79.00
22303	30W	LED Strahler «Quader» Bridgelux 45mil, 50/60Hz, 95-265V, 100-120° L215xB178xH81, 1.240kg	80	2700K 3000K 4000K* 5000K/6500K*	2400-3000lm	IP65	88.21 / 95.00
22344	50W	LED Strahler «Quader» Bridgelux 45mil, 50/60Hz, 95-265V, 100-120° L253xB194xH95, 1.830kg	80	2700K* 3000K 4000K* 5000K/6500K*	4000-5000lm	IP65	129.06 / 139.00
22346	100W	LED Strahler «Quader» Bridgelux 45mil, 50/60Hz, 95-265V, 100-120°, (2x50W) L340xB250xH116, 4.450kg	80	2700K* 3000K 4000K 5000K/6500K*	8500-10000lm	IP65	370.47 / 399.00
22349	200W	LED Strahler «Quader» Bridgelux 45mil, 50/60Hz, 95-265V, 100-120°, (4x50W) L400x340xH192, 8.540kg	80	2700K* 3000K* 4000K* 5000K/6500K*	16000- 18000lm	IP65	463.32 / 499.00

\* = nicht lagernd, 2-3 Wochen Lieferfrist

Auf Wunsch können wir die LED Strahler «Quader» mit LED Chip (Bridgelux 45mil) mit Farbwiedergabeindex von über Ra90 ausrüsten. Sprechen Sie uns an. Wir beraten Sie gerne.

Die Strahler sind auch als 1-10V oder DALI sowie mit Fernbedienung und Funk-Taster verfügbar.

Preise exkl. MWST. Grössere Mengen auf Anfrage. Preisänderungen vorbehalten. Januar 2020



## PREISLISTE

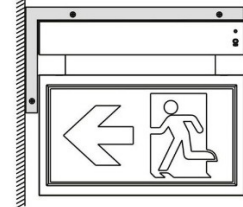

### LED-Rettungszeichenleuchte sw 3.2W 320lm

3h, LI-ION, 3.7V, 4W, 2600mAh, Selbsttest Optik Fläche  
 Dauerbetrieb/Bereitschaftsbetrieb

ART. NR.	WATT	BEZEICHNUNG	Ra/CRI	KELVIN	LICHTSTROM	IP	PREIS CHF exkl. / inkl. MWSt
SPA-80010 Inkl. Piktogramme	3.2 Watt	LED-Rettungszeichenleuchte Economy 330x248x45mm weiss Erkennungsweite 30m Einzelbatterie 3h, Kunststoff	80	6000K	350lm	IP20	138.35 / 149.00
SPA-80012		Seitliche Wandhalterung zu		passend zu	SPA-80010		36.21 / 39.00
SPA-80023		Einbaurahmen zu Rettungszeichenleuchte		passend zu	SPA-80010		29.72 / 32.00
<b>Alle Piktogramme 2-fach und 1x weisse Abdeckung inkl. Decken- / Wandmontage (seitliche Wandmontage mit Zubehör) max. 1000mm gependelt</b>							
SPA-80024	3.2 Watt	LED-Rettungszeichenleuchte Economy 330x248x45mm weiss Erkennungsweite 30m Einzelbatterie 3h, Kunststoff Piktogramme links, recht nach unten		6000K	320lm		119.78 / 129.00



### LED-Sicherheitsleuchte 2-6m 220lm

3h, LI-ION, 3.7V, 4W, 2600mAh, Selbsttest Optik Fläche  
 Dauerbetrieb/Bereitschaftsbetrieb

ART. NR.	WATT	BEZEICHNUNG	Ra/CRI	KELVIN	LICHTSTROM	IP	PREIS CHF exkl. / inkl. MWSt
SPA-80030 Weiss Deckenmontage	4 Watt	Sicherheitsleuchte rund 2-6m, Einzelbatterie 3h 130x130x56.4mm Kunststoff	80	6000K	220lm	IP20	110.49 / 119.00
SPA-80031 Weiss Deckenmontage	4 Watt	Sicherheitsleuchte quadrat 2-6m, Einzelbatterie 3h Ø130x56.4mm, Kunststoff	80	6000K	220lm	IP20	110.49 / 119.00
SPA-80032 Weiss Bohrloch 45mm	4 Watt	<b>Einbau</b> -Sicherheitsleuchte 2-6m, Einzelbatterie 3h Ø55x27.8mm Kunststoff	80	6000K	220lm	IP20	110.49 / 119.00

Preise exkl. MWST. Grössere Mengen auf Anfrage. Preisänderungen vorbehalten. April 2021





## PREISLISTE

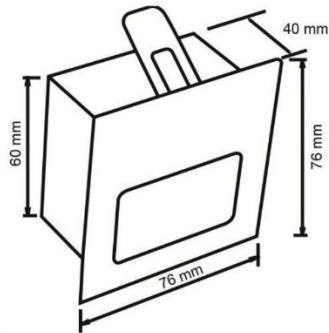

### LED-Wandeinbauleuchte Floor Alu gebürstet Einbaugehäuse für Gips und Backstein / Einbetonierungsgehäuse

ART. NR.	WATT	BEZEICHNUNG	Ra/CRI	KELVIN	LICHTSTROM	IP	PREIS CHF exkl. / inkl. MWSt
SPA-37020	2.5W	LED-Wandeinbauleuchte Floor Alu gebürstet, Aluminium Abstrahlwinkel: diffus, Einbautiefe/Breite: 40x60mm Aussenmasse: 76x76x40mm	80	3000K	250lm	IP20	69.54 / 74.90
SPA-37021		Einbaugehäuse für Gips und Backstein zu SPA-37020					19.03 / 20.50
SPA-37022		Einbetonierungsgehäuse zu SPA-37020					109.56 / 118.00



SPA-37022



SPA-37022

Preise exkl. MWST. Grössere Mengen auf Anfrage. Preisänderungen vorbehalten. April 2021

